

## GV-BX2600 2MP H.264 Super Low Lux WDR D/N Box IP Camera



- 1/2.8" progressive scan super low lux CMOS
- Min. illumination at 0.02 lux
- Dual streams from H.264 and MJPEG
- Up to 60 fps at 1920 x 1080
- 2-way audio
- One sensor input and alarm output
- TV-out support
- Built-in micro SD card slot (SD/SDHC) for local storage
- Mini USB slot for WiFi Adapter or USB hard drive
- Wide Dynamic Range Pro (WDR Pro)
- 3D noise reduction
- Motion detection
- Video Analytics (Intruder, Loitering, People Counting, Unattended Object, Missing Object, and Tampering Alarm)
- Privacy mask
- IP address filtering
- DC 12V / PoE (IEEE 802.3af)
- Removable IR-cut filter for Day/Night function
- Varifocal megapixel lens
- Supports iPhone, iPad, Android & 3GPP
- 31 languages on Web interface
- ONVIF (Profile S) conformant

\* No Memory card slot & local storage function for Argentina.

\* GV-VMS V15.10 (coming) is required for Video Analytics function

### Introduction

GV-BX2600 is a brand-new model of Box Camera series. It comes with a sensor featuring Wide Dynamic Range Pro (WDR Pro) and Super Low Lux to provide clear images not only under contrasting light intensities but also in the darkness. Compared to standard 2 MP cameras which deliver 1080p at maximum 30 fps, GV-BX2600 achieves 60 fps under certain conditions.

Moreover, GV-BX2600 can intelligently process video analytics onboard—Intruder, Loitering, People Counting, Unattended Object, Missing Object, and Tampering Alarm—to identify motion, find and trace objects and even produce alarms on unusual activities.

### Dimensions

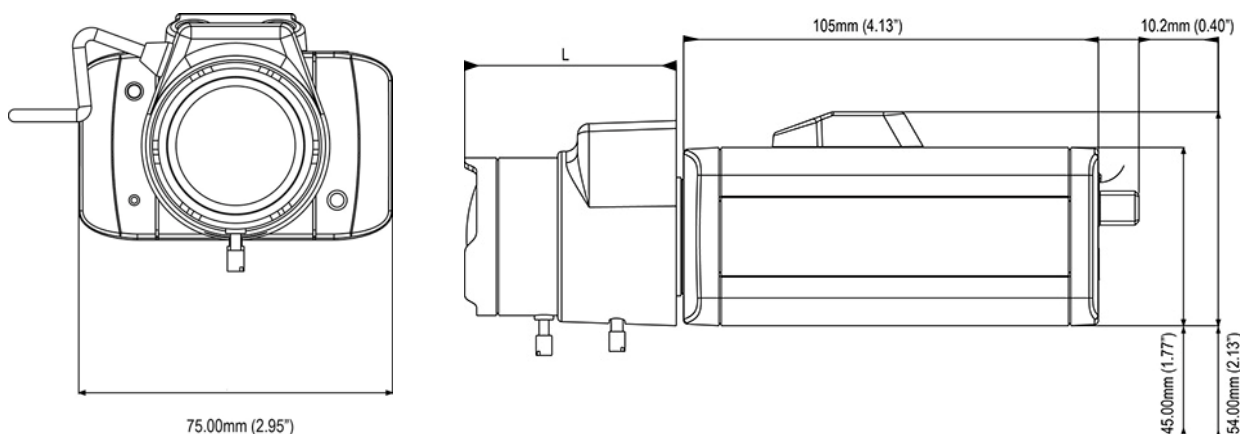

## Specifications

<b>Camera</b>		<b>GV-BX2600</b>
Image Sensor		1/2.8" progressive scan super low lux CMOS
Picture Elements		1920 (H) x 1080 (V)
Minimum Illumination	Color B/W	0.02 Lux
	IR ON	0 Lux
Shutter Speed		Automatic, Manual (1/5 ~ 1/8000 sec)
White Balance		Automatic, Manual (2800 ~ 8500K)
Gain Control		Automatic
S/N Ratio		52 dB
WDR Pro		Yes (with WDR sensor)
Dynamic Range		Up to 110 dB
<b>Lens</b>		
Megapixel		Yes
Day/Night		Yes (with removable IR-cut filter)
Lens Type		Varifocal
Focal Length		3 ~ 10.5 mm
Maximum Aperture		F/1.4
Mount		CS Mount
Image Format		1/2.7"
Horizontal FOV		96° ~ 34°
Operation	Focus	Manual (w/lock)
	Zoom	Manual (w/lock)
	Iris	DC drive
Torque (Focus/Zoom screws)		0.049 N.m
<b>Operation</b>		
Video Compression		H.264, MJPEG
Video Streaming		Dual streams from H.264 or MJPEG
Frame Rate		60 fps 1920 x 1080 * The frame rate and performance may vary depending on the number of connections and data bitrates (different scenes).
Image Setting		Brightness, Contrast, Saturation, Sharpness, Gamma, White Balance, Flicker-less, Image Orientation, Shutter Speed, D/N Sensitivity, Video Analytics
Video Analytics		Motion Detection, Advanced Video Analytics (Intruder, People Count, Loitering), Unattended Object Detection, Missing Object Detection
Audio Compression		G.711
Audio Support		Two-Way Audio
Sensor Input		1 input (Dry Contact)
Alarm Output		1 Digital Output (200mA 5V DC)
<b>Video Resolution</b>		
Main Stream	4:3	1280 x 960, 640 x 480, 320 x 240
	16:9	1920 x 1080, 1280 x 720, 640 x 360, 448 x 256
	5:4	1280 x 1024, 640 x 512, 320 x 256
Sub Stream	4:3	640 x 480, 320 x 240
	16:9	640 x 360, 448 x 256
	5:4	640 x 512, 320 x 256
<b>Network</b>		
Interface		10/100 Ethernet
Protocol		DHCP, DynDNS, FTP, HTTP, HTTPS, NTP, ONVIF (Profile S), PSIA, QoS (DSCP), RTSP, SNMP, SMTP, TCP, UDP, UPnP, 3GPP/ISMA
Wireless LAN		IEEE 802.11 b/g/n
Antenna Type		External
Security		WEP, WPA-PSK(TKIP), WPA-PSK(AES), WPA2-PSK(TKIP), WPA2-PSK(AES)

<b>Mechanical</b>		
Temperature Detector	Yes	
Connectors	Power	2-pin terminal block, PoE
	Ethernet	RJ-45
	Audio	1 In (Externally connecting a microphone) 1 Out (Stereo phone jack, 3.5 mm / 0.14")
	Digital I/O	3-pin terminal block, pitch 2.5 mm (0.1")
	Auto Iris	Yes (with varifocal lens)
	Local Storage	Micro SD card slot (SD/SDHC, SD version 2.0 only, Class 10) *SDXC and UHS-I card types are not supported.
	TV-Out	BNC connector (640 x 480 resolution)
Mini USB	GV-WiFi Adapter or USB hard drive	
LED Indicator	2 LEDs: Power, Status	
<b>General</b>		
Operating Temperature	0 °C ~ 50 °C (32 °F ~ 122 °F)	
Humidity	10% to 90% (no condensation)	
Power Source	12V DC / PoE (IEEE 802.3af)	
Max. Power Consumption	7.5 W	
Dimensions (without lens)	105 x 75 x 54 mm (4.13" x 2.95" x 2.13")	
Weight	321 g (0.71 lb)	
Regulatory	CE, RCM, FCC, LVD, RoHS compliant	
<b>Power over Ethernet</b>		
PoE Standard	PoE (IEEE 802.3af Class 3 Power over Ethernet / PD)	
PoE Power Supply Type	End-Span	
PoE Power Output	Per Port 48V DC, 350mA. Max. 15.4 watts	
<b>Web Interface</b>		
Installation Management	Web-based configuration	
Web Browser	Microsoft Internet Explorer 11 or later / Google Chrome / Mozilla Firefox / Safari	
Maintenance	Firmware upgrade through Web Browser or Utility	
Access from Web Browser	Camera Live View, Video Recording, Change Video Quality, Bandwidth Control, Image Snapshot, Digital I/O control, Audio, Picture in Picture, Picture and Picture, Privacy Mask, Visual Automation, Text Overlay, Digital PTZ	
Language	Arabic / Bulgarian / Czech / Danish / Dutch / English / Finnish / French / German / Greek / Hebrew / Hungarian / Indonesian / Italian / Japanese / Lithuanian / Norwegian / Persian / Polish / Portuguese / Romanian / Russian / Serbian / Simplified Chinese / Slovakian / Slovenian / Spanish / Swedish / Thai / Traditional Chinese / Turkish	
<b>Applications</b>		
Network Storage	Network Storage	
Smart Device Access	Smart Device Access	
Live Viewing	Live Viewing	
CMS Server support	CMS Server support	

**Note:**

- The signal range and data throughput may vary depending on the network conditions and environmental factors.
- Mind the following limitations and requirements for the mini USB port:
  - The USB hard drive must be of 2.5" or 3.5", version 2.0 or above
  - The USB hard drive's storage capacity must not exceed 2TB
  - USB flash drives and USB hubs are not supported
  - External power supply is required for the USB hard drive
  - To connect a GV-WiFi Adapter, make sure it is connected before the camera is powered on.
- Specifications are subject to change without notice.
- Mind the following when using a memory card for recording:
  - Recorded data on the memory card can be damaged or lost if the data are accessed while the camera is under physical shock, power interruption, memory card detachment or when the memory card reaches the end of its lifespan. No guarantee is provided for such causes.
  - The stored data can be lost if the memory card is not accessed for a long period of time. Back up your data periodically if you seldom access the memory card.
  - Memory cards are expendable and their durability varies according to the conditions of the installed site and how they are used. Back up your data regularly and replace the memory card annually.
  - To avoid power outage, it is highly suggested to apply a battery backup (UPS).
  - For better performance, it is highly suggested to use Micro SD card of MLC NAND flash, Class 10.





- Replace the memory card when its read/write speed is lower than 6 MB/s or when the memory card is frequently undetected by the camera.
- 5. When GV-BX2600 uses Micro SD card or USB HDD for recording, the camera must not have more than one connection to GeoVision or third-party software.
- 6. Mind the following restrictions, without regard to the resolution of the camera images, when the GV-BX2600 camera is set to 60 fps:
  - The codec MJPEG is not available in the main stream.
  - Dual streaming is not supported.
  - Video analysis functions, including motion detection, are not supported.
  - TV-out is not supported.
  - The frame rate will be dropped to 30 fps during live streaming and recording when the camera starts monitoring.
  - WDR Pro function is not supported.
  - 1 or 2 fps will be dropped on the point of obtaining snapshots in JPEG format with the CGI command.



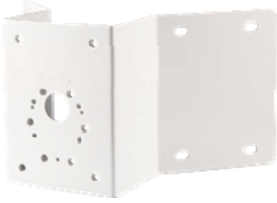

### Packing List

- |  |                                |
|--|--------------------------------|
| 1. Box Camera                              | 7. Holder Screw x 2            |
| 2. Terminal Block                          | 8. Power Adapter               |
| 3. Fixed Focal or Varifocal Megapixel Lens | 9. GV-IPCAM H.264 Software DVD |
| 4. Six Lens Rings                          | 10. GV-NVR Software DVD        |
| 5. Video Out Wire                          | 11. Warranty Card              |
| 6. Camera Holder                           |                                |

**Note:** The power adapter can be excluded upon request.

### Accessories

Model No.	Name	Details
GV-Mount300	Convex Corner Adapter Kit	Dimensions: 238.6 x 409.5 mm (9.4" x 16.1") Weight: 4.27 kg (9.41 lb)
		
GV-Mount310	Concave Corner Adapter Kit	Dimensions: 123.3 x 393.1 mm (4.9" x 15.5") Weight: 2.96 kg (6.53 lb)
		
GV-Mount400	Pole Mount Bracket Kit (Ø 4" ~ 6")	Bracket Dimensions: 241 x 161 mm (9.5" x 6.3") Weight: 1.70 kg ( 3.75 lb) Steel Strap Diameter: Ø 4" ~ 6"
		
GV-Mount410	Pole Mount Bracket Kit (Ø 6" ~ 7.5")	Bracket Dimensions: 241 x 161 mm (9.5" x 6.3") Weight: 1.70 kg (3.75 lb) Steel Strap Diameter: Ø 6" ~ 7.5"
		

Model No.	Name	Details
GV-Housing101 <b>IP67</b> <b>IK10</b>	Housing Box (with heater and fan) 	Dimensions: 406 x 145 x 109 mm (16 x 5.7 x 4.3") Weight: 4.69 kg ( 10.34 lbs) (including Supporting Tube) Start-up Temperature: -30°C ~ 50°C (-22°F ~ 122°F) Operation Temperature: -40°C ~ 50°C (-40°F ~ 122°F) Heater: 15°C (59°F) On / 25°C (77°F) Off Fan: 35°C (95°F) On / 25°C (77°F) Off Power board: 24V AC or 12V DC input
GV-PA191 PoE Adapter		Weight: 130 g / 0.29 lb Dimensions (H x W x D): 43 x 69 x 40 mm / 1.69 x 2.72 x 1.57 in
GV-WiFi Adaptor		Weight: 20 g / 0.04 lb Dimensions (H x W x D): 15 x 15 x 155 (mm) / 0.59 x 0.59 x 6.10 (in) Supplied with mini USB to standard USB adapter.
GV-Relay V2		The GV-Relay V2 is designed to expand the voltage load of GV IP devices. It provides 4 relay outputs, and each can be set as normally open (NO) or normally closed (NC) independently as per your requirement.
Power Adapter		Contact your sales representative for the countries and areas supported.
GV-POE Switch		The GV-POE Switch is designed to provide power along with network connection for IP devices. The GV-POE Switch is available in various models with different numbers and types of ports.